

MOUNTING INSTRUCTION
MONTAGEANLEITUNG
INSTRUCTION DE MONTAGE
MONTAGEHANDLEIDING
ISTRUZIONI PER IL MONTAGGIO
INSTRUCCIONES DE MONTAJE

AV-02
AV-04

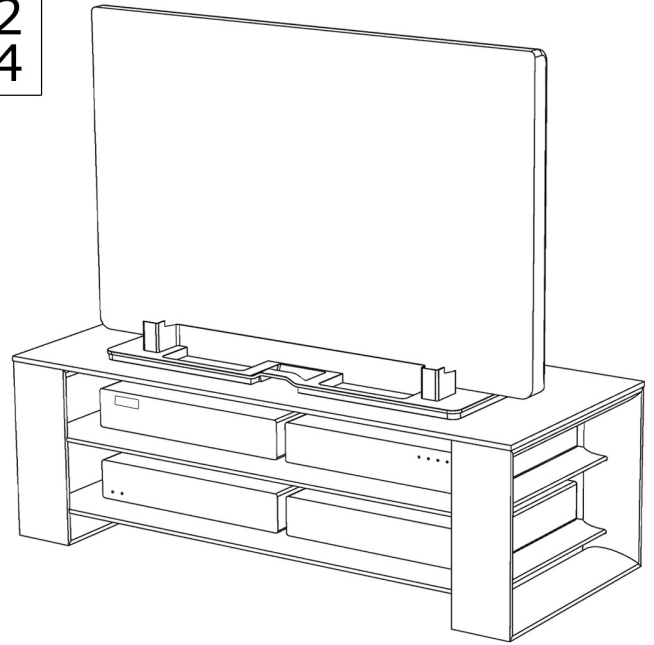
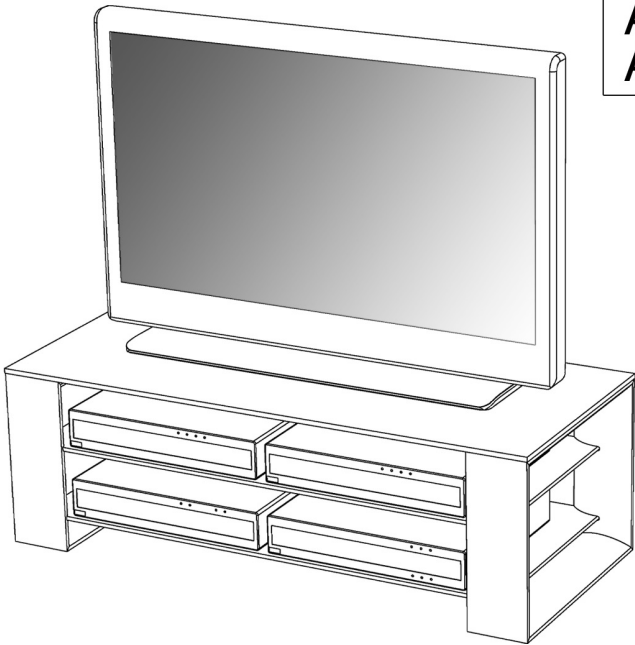

parts list

A 1x

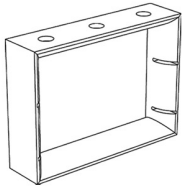

B 1x

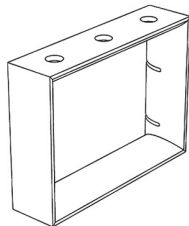

C 2x

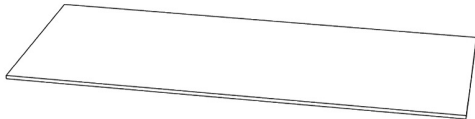

D 1x

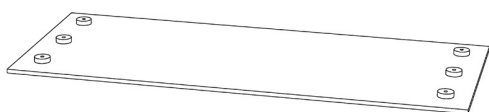

E 6x

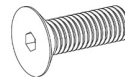

F 1x

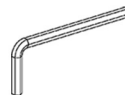

G 1x

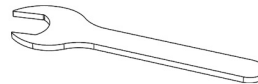

H 1x

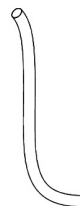

25.001.190.002.001

